

FEATURES

- 1-pole, 3-contacts self return slide switch
- Suitable for SMT reflow soldering
- Unique combination of slider and cover provides 6 different kinds of operation and tactile feel
- Vertical/horizontal operation knobs are available

APPLICATIONS

- Smartphones
- Video players
- Remote controllers
- Zoom function for camera
- Power switches, hold switches, mold select switches

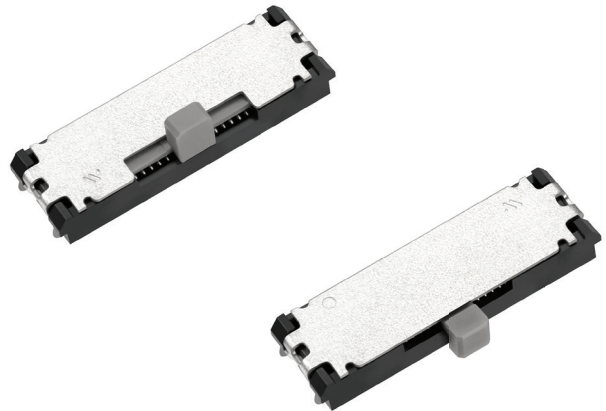

PART NUMBER CODE

Series	Number of Circuits	Number of Contacts	Earth Terminal	Self Return	Orientation	Packaging
SSA	1	3	1 (without)	F K G M H P	H (horizontal) V (vertical)	T (taping)

Self Return Code	Side A: a↔b		Side B: b↔c	
	Self Return	Detent	Self Return	Detent
F	o		o	
G	o			o
H	o			
K		o	o	
M			o	
P		o		o

SPECIFICATIONS

Switch Type	SP3T	Slide
Electrical Characteristics	Rating (Resistive Load)	DC 4V, 0.3 A
	Contact Resistance	1Ω or less
	Insulation Resistance	10MΩ or more
	Withstand Voltage	1 minute at AC 100V
Mechanical Characteristics	Operating Force	Self return section: 1.2 ± 1.0N
		Click section: 1.5 ± 1.0N
Life		50,000 cycles

TYPE

Model Name	Model No.	Number of Poles	Number of Contacts	Travel	Knob Direction	Pcs/Reel
SSA-131FHT	R 666804	1	3	1.5mm	Horizontal	5,000
SSA-131FVT	R 666792	1	3	1.5mm	Vertical	3,000

DIMENSIONS

SSA-131FHT

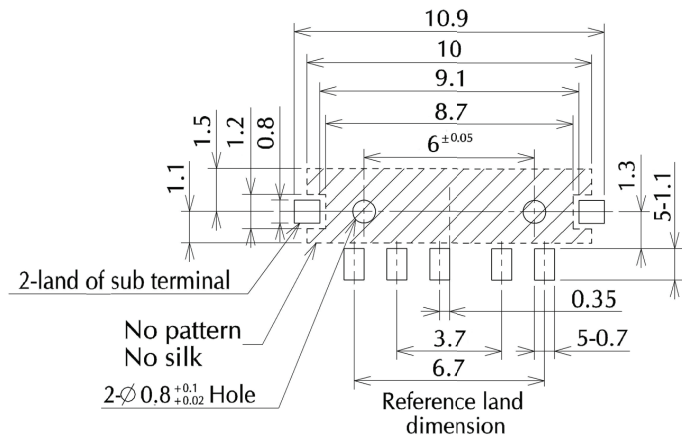
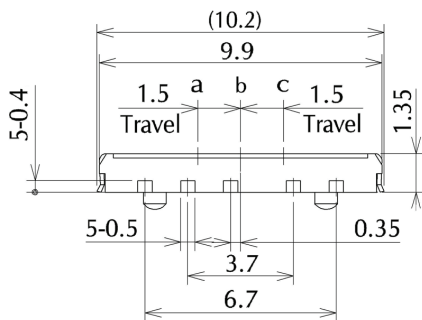
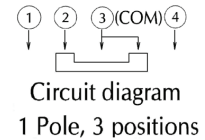
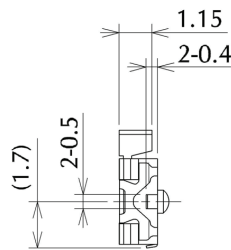
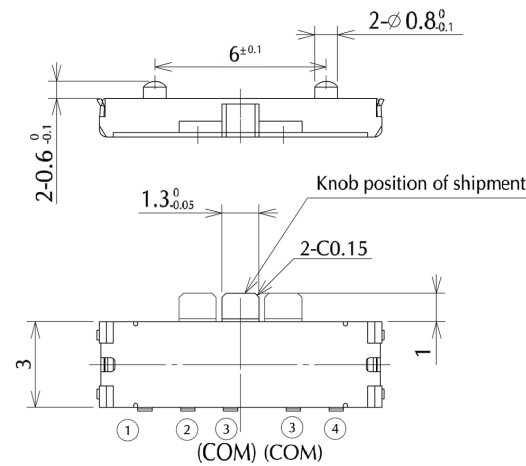

SSA SERIES

Self Return Slide Switch

MITSUMI

TACTILE SWITCHES

SLIDE SWITCHES

SWITCH SHEETS

SWITCH KITS

DIMENSIONS

SSA-131FVT

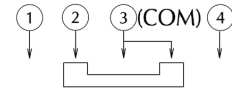
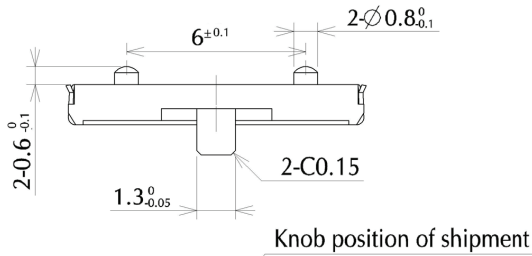

Circuit diagram
1 Pole, 3 positions

